



Installation Instructions

Part number 1099XX, Frameless Soft Top
for
2 door Jeep® Wrangler JK 2007-

NOTE: Installation of the top in warm weather is optimal for ease of installation. Ideal installation temperature should not be less than 70° (21C). Initial installation is the most difficult as the fabric has not been stretched. The top will loosen slightly with use and warm temperature. Allow about at least an hour for the initial installation.

Please follow instructions for ease of installation and correct fit.

Included:

- 1 x Top components (Top, side windows, Rear window, window storage bag)
- 2 x Aluminum poles

Required Tools:

Phillips screw driver to remove original soft top. Torx sockets are required to completely remove the original soft top hardware.

Step 1. Remove existing soft or hard top. For OEM (original/factory) soft tops: remove header bar, remove tube frame hardware from roll bar, and remove the rear window/tailgate bar and set it aside for the new top. Keep the rear bar mounting hardware in place on the body as the rear bar will be re-used. Keep the door surrounds in place as they will also be used.

Step 2. Inspect the clearance between top of windshield frame and door surround, making sure that the factory foam seal is in place; door surrounds are properly placed and tightened per Jeep® owners manual. Inspect rear Tailgate Bar and Clips that they are securely mounted and they are in good working condition. **NOTE. The factory door surrounds have an extrusion that was added for the 2010 model year or later. This added extrusion must be removed to work with the Rampage Frameless top. Please see Figure 1 below for further detail. You can also chose to use the Rampage door surrounds (available 2013) or a set of surrounds from a 2007-2009 JK. We recommend the use of the Rampage surround kit as it was designed specifically for this top.**

For 2010 or later Door Surrounds

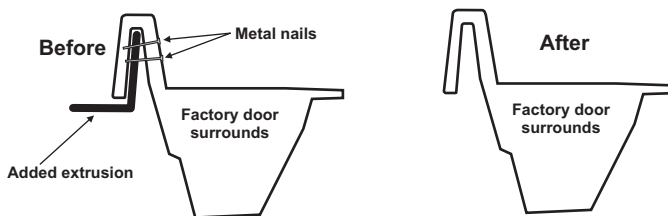

The 2010 model year or later has an added extrusion nailed into the original surround that needs to be removed to work properly with the Rampage Frameless Top. It is easily removed, the surrounds will still work fine with the factory top, and the extrusion can be quickly re-installed as desired. Simply pull the extrusion out from the nails or remove the nails themselves.

Figure 1

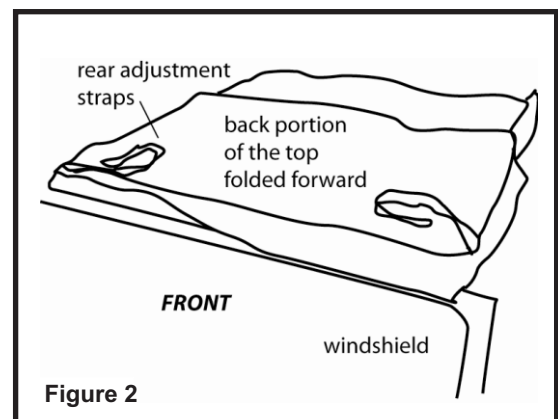

Figure 2

Step 3. Unfold your new Soft Top, set the windows aside for later use, taking care not to scratch windows. Place the top on the center of the roll bar and unfold. Spread the top out and taking care that the metal flat hooks at the end of the rear adjustment straps do not damage paint, glass or cause injury. See Figure 2.

Step 4

- a. Install the top onto the header channel using the snaps as shown in the illustration. (fig. 3)
- b. Place the header channel with the top installed above the windshield on the gasket and fold the combo top forward over the windshield.
- c. Insert the tab of the header channel into the footman loop on the vehicles windshield frame as shown. (fig.4)

Fig 3

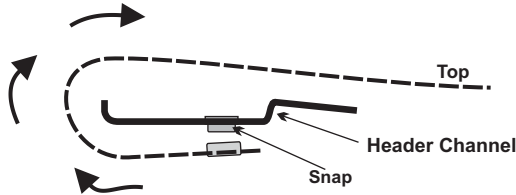

Fig 4



- d. Place the metal bracket in place on under the header channel as shown. (fig. 5).
- e. Insert the threaded knob into the metal bracket and tighten. (fig. 6) Repeat for other side.

Fig 5



Fig 6



Step 5. Once the header channel and top have been installed on the windshield frame, fold the top back over the roll cage of the vehicle and spread it out. Insert plastic into the top of the door surround channels above either door opening. This will center the top at the front.

Step 6. Wrap the two straps at the center of the top main section around the rear of the main roll bar and hook the plastic hooks into the holes on the under side of the roll bar. Push the hooks into the hole and then pull back to hook the clip on the inside sheet metal. Tighten snugly so there is some tension on this strap.
NOTE: So as not to over tighten, do not use any tools to tighten this strap. See fig. 7 & 8.

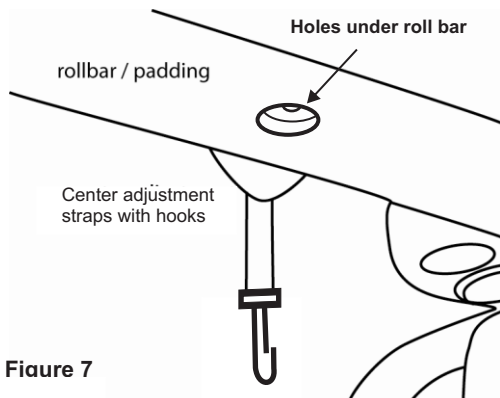

Figure 7

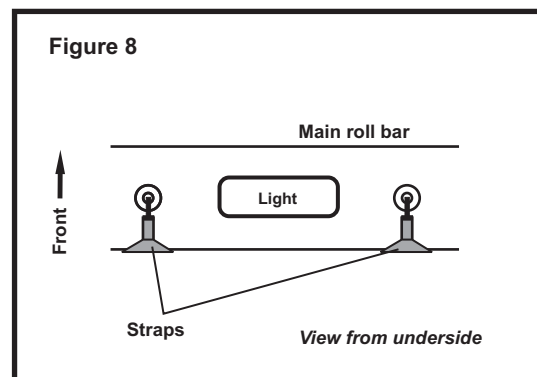
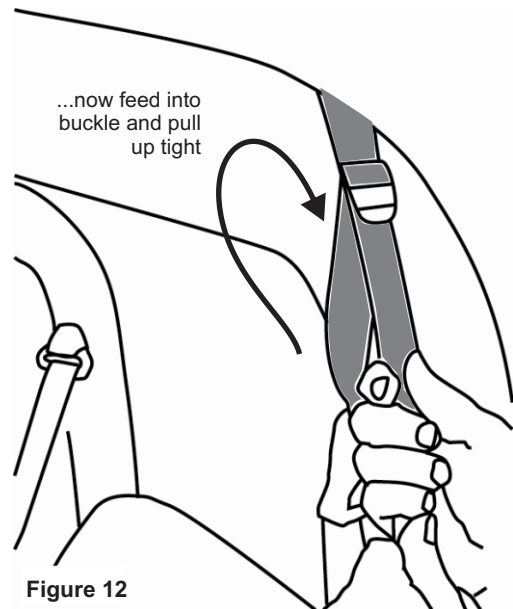
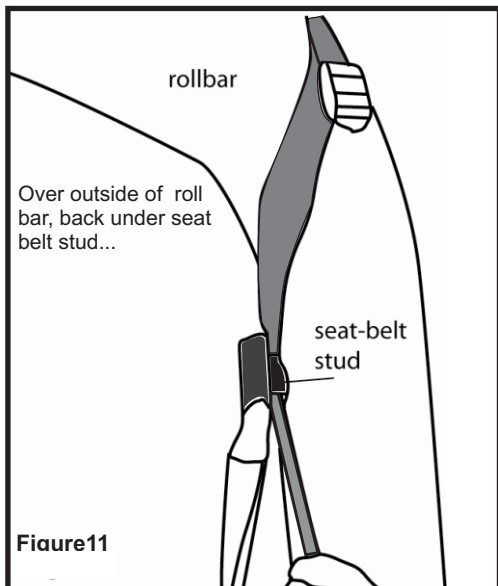
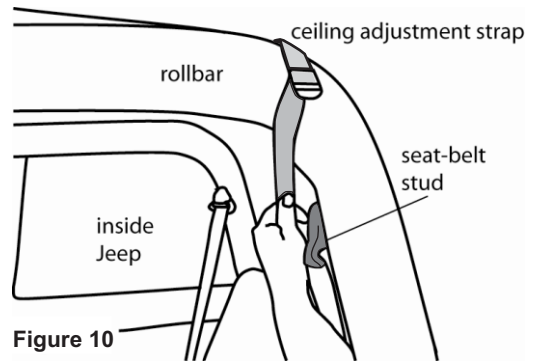
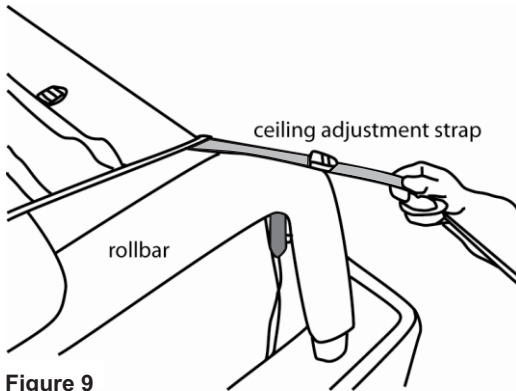

Figure 8

Step 7. Locate the ceiling adjustment straps (at rear corners on ceiling panel). Gently pull the strap over the rollbar, and around the seatbelt stud (toward the inside) and back up to the strap adjustment buckle. Tighten snug, and perform same procedure on the other side. Check top for evenness from side to side. See Figures 9, 10, 11, & 12.



Step 8. Install the side windows by mating the zippers to the main skin and zip the sliders all the way along both sides. Loosely attach the rear window to the three straps on top rear. Mate the rear window zippers to the top on both sides. **NOTE: See figure 13 for detailed order instructions for installation of the zippers and channel inserts.**

Step 9. Continue attaching the Belt Rail plastic of the side windows from front to back, starting on the back top of the door surrounds. Hook the Belt Rail plastic to the back section of the door surround.

Figure 13

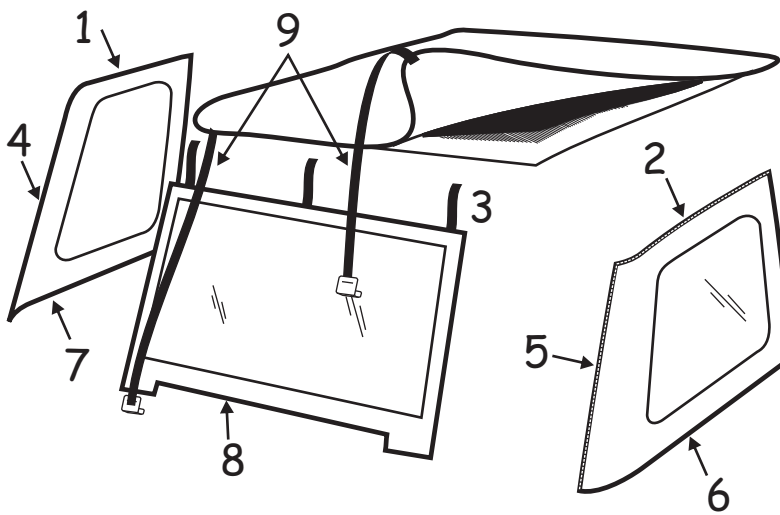

Panel/Zipper installation order:

- 1, 2 - Zippers to main skin
- 3 - Rear panel straps (x3) loose
- 4, 5 - Side panels to rear window
- 6, 7 - Plastic strip into body channel
- 8 - Tailgate bar
- 9 - Rear straps

- Step 10.** Prior to continuing; make sure rear panel zippers have been started on both sides. Set the Belt Rail plastic even with the factory weather strip at the body gutter – directly behind the door. Continue fastening the plastic under the Belt Rail lip of the body until the top is fully attached around the back corners of the body.
- Step 11.** Slide rear bar into the tube plastic on the bottom of the rear window. Insert the Tailgate Bar into the side clips, check for evenness from side to side. Rotate the bar towards the inside to lock it in place same as the factory installation. Zip the rear window and pull the Hook and Loop a.k.a. “Velcro” closed.
- Step 12.** On top of the rear part of the roll bar pull the side to side adjustment straps snug, do not over tighten. Pull the three rear window straps snug.
- Step 13.** Pull the roof top down. Handle the metal hooks on the end of the straps with care to avoid damage or injury. Attach the flat hooks under the Belt Rail at the reinforced patches on each side of tailgate, and pull the straps down snug (WITH ONE HAND). While holding the straps in-line and secured to the hook and loop, close the cam buckle into the locked position.

The Front Bow inserts

The aluminum bows in the front section of the top are intended primarily to keep water from pooling on the front section of the top in heavy rains. Without the bows it is possible for water to pool in the front section of the top and cause issues with the seams because of the weight. They will also keep the top from fluttering if it is installed properly. The bows are easily removed by flexing the inner rod and removing from the pockets. The top will function normally without them, however It is recommended they be used in heavy rains when parked.

Storing Windows

To store your windows, begin by removing the hooks from the rear Belt Rail and flipping the top to expose the storage bag. Again, take care *not* to fling the top to avoid metal hooks causing damage or injury. Remove the windows and store them in the bag utilizing the window separation panels to protect the window.

Important Care Instructions:

Convertible tops and accessories require special care if you want to get the maximum usage and enjoyment from them. The following recommendations, if followed carefully, can extend the life of your top or accessory.

Hand wash using a mild non-detergent soap such as ivory. Use a non-abrasive cloth or sponge. Rinse thoroughly.

Do not wash in direct sunlight and avoid automatic car washes

When your top is clean, we recommend using "Ragg Topp" or "303 Protectant" on both the vinyl top and windows. This product contains a sunscreen that helps protect from the sun's damaging rays. Stay away from products containing alcohol, as it will cause the fabric and windows to lose their elasticity, thus reducing the life of your top or accessory. If you are unable to locate "RaggTopp" Please call 1-800-377-4700 for a distributor near you. For "303 Protectant", please call 1-800-223-4303 for a distributor near you.

Direct sunlight and heat are the biggest enemies of the windows. Park in the shade whenever possible. If you must park in the sunlight, rotate the direction that you park every few days so all windows get even exposure.

Our tops are designed so that you may roll up and/or store the rear curtain and side curtains. To prevent scratching of the windows, be sure that windows are completely clean and free of dust particles. Even a little dirt will badly scratch the windows. You may want to use a soft cloth when rolling up or storing your windows. Heat may build up on rolled up windows, so be sure to unroll them frequently. If you roll up the windows at the beginning of summer and leave them, they may be ruined by fall.

Do not open or roll up windows at temperatures below 45 degrees F this could cause them to crack or break.

Zipper Care.

DO NOT use pliers or other tools to pull on zippers. If the zipper requires more force than pulling with your fingers something is most likely out of alignment or improperly installed. Be sure the top is up to a temperature of 70 deg., and that the components are installed correctly and in the correct sequence to ensure protection of the zipper.

Zippers require periodic cleaning and lubrication to ensure longevity and ease of use. Clean by wiping with a towel soaked in soap and water, DO NOT USE HARSH CHEMICALS. Zipper lubricants are available at sporting goods stores and online for wetsuits. An occasional use will keep the zipper slides operating as new.

Warranty Information

Rampage products, Inc. warrants to the original purchaser of any top it manufactures, that the top will be free of defects in material or workmanship for a period of 2 year from date of purchase. Such obligations under this warranty shall be limited to the repair or replacement, at Rampage products discretion, of any assembly or parts which, upon examination by Rampage products, Inc. proves to be defective. All defective items must be returned with proof of purchase to Rampage products, Inc., freight prepaid. This warranty does not cover damage resulting from abuse, misuse, alteration, accident or damage in transit. Rampage products obligations under this warranty are limited to the aforementioned repair or replacement of warranty defects for which the return authorization has been received during the warranty period, and Rampage products, Inc. shall not be liable for any incidental or consequential damages arising from breach of this or any implied warranty.

Rampage Products 9225 Stellar Ct. Ste "C", Corona, CA 92883 Phone: (951) 277-4949 Fax: (951) 277-2295

www.rampageproducts.net

Made in China